

## Zakázaný okap v rohu podél svislých stěn

Zadání č. 1 (a, b = a)

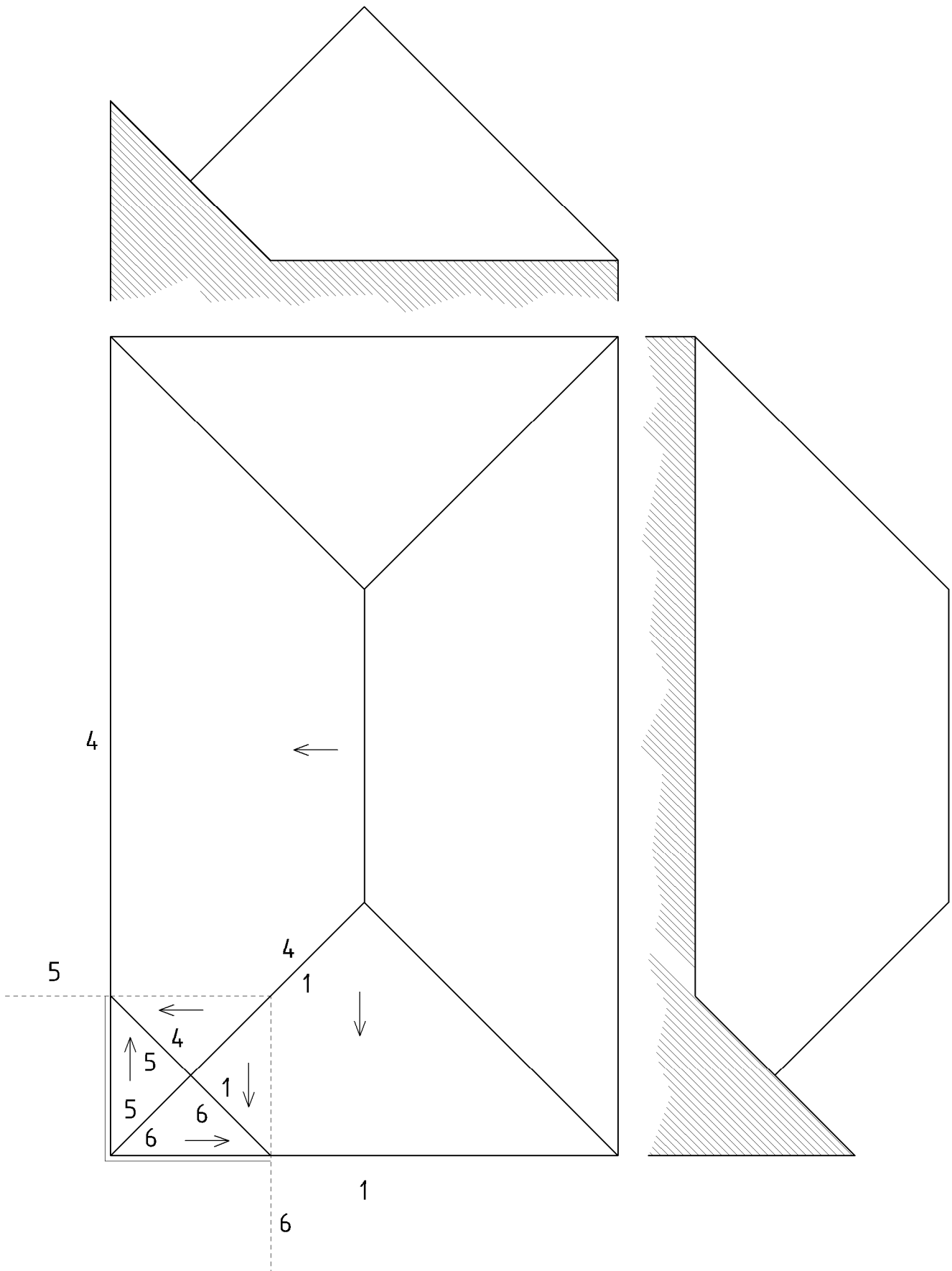

Zadání č. 2 (  $a, a < b < 2a$  )

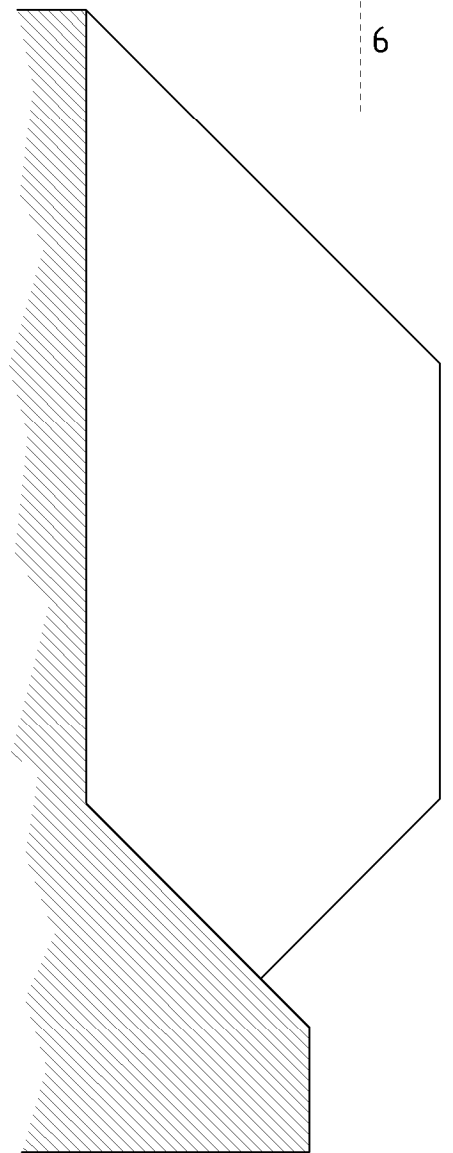
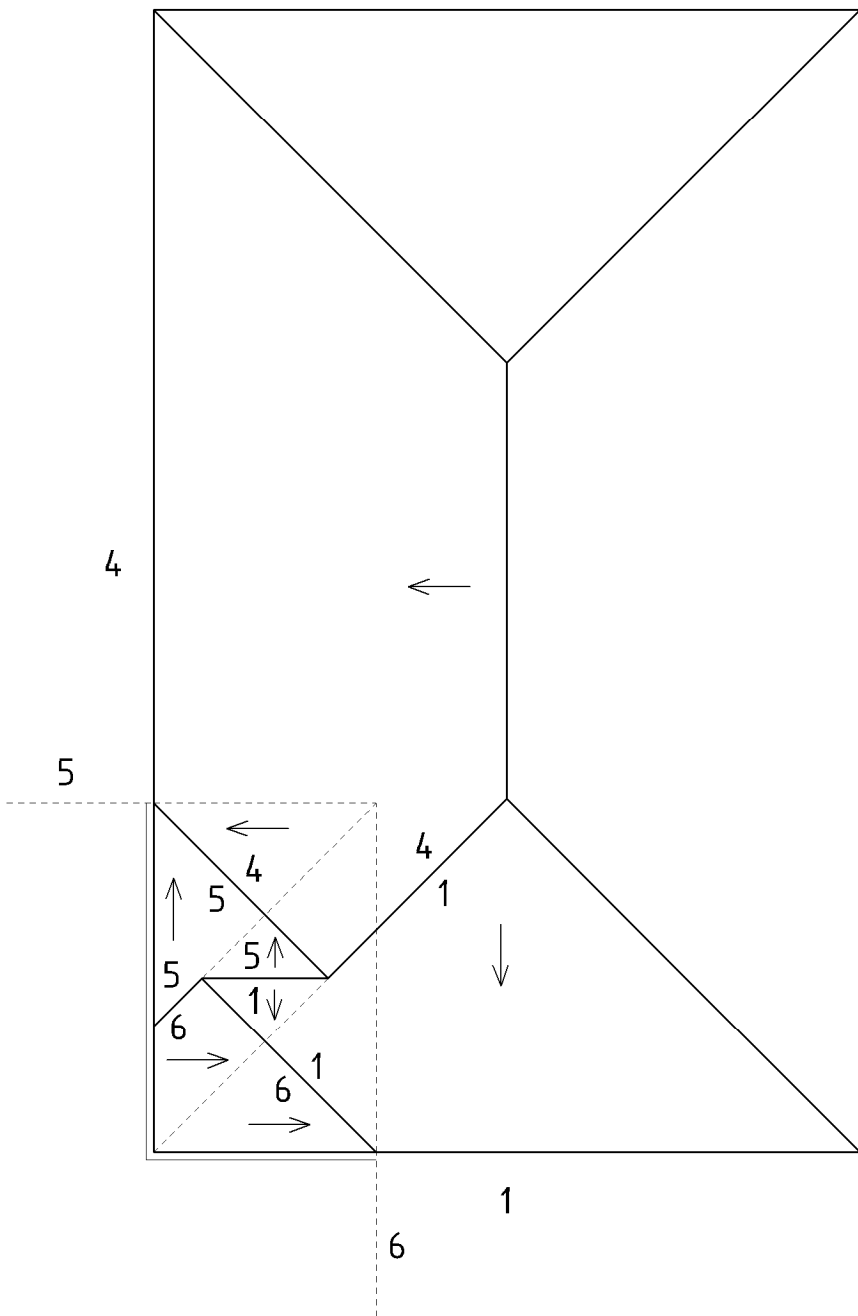
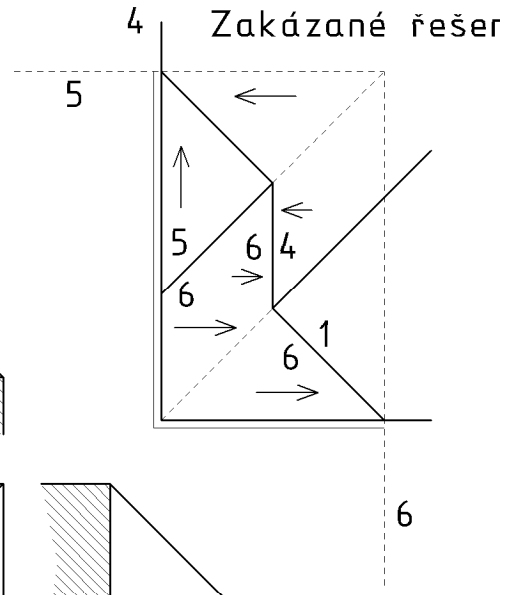
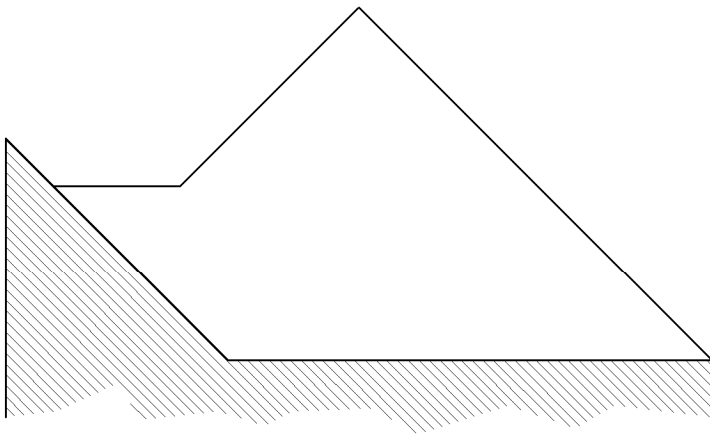

Zadání č. 3 ( a, b = 2a )

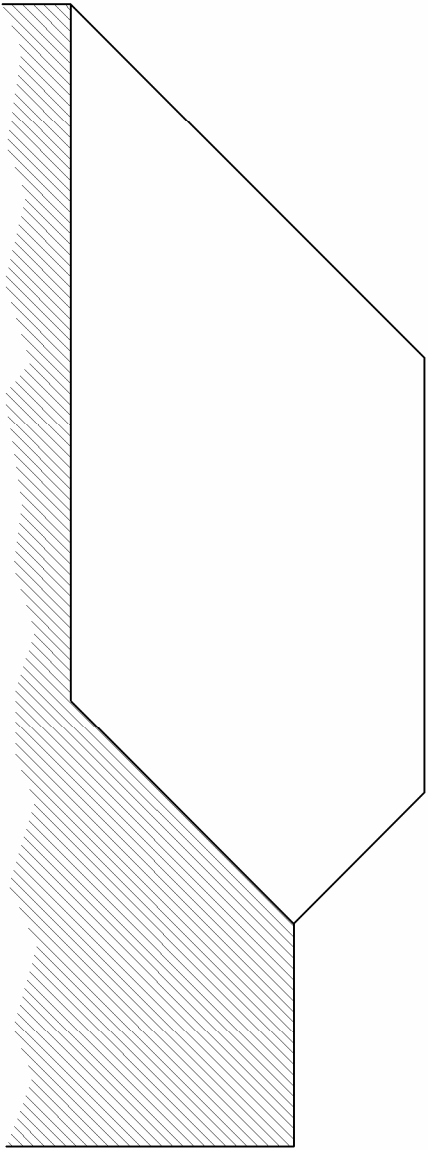
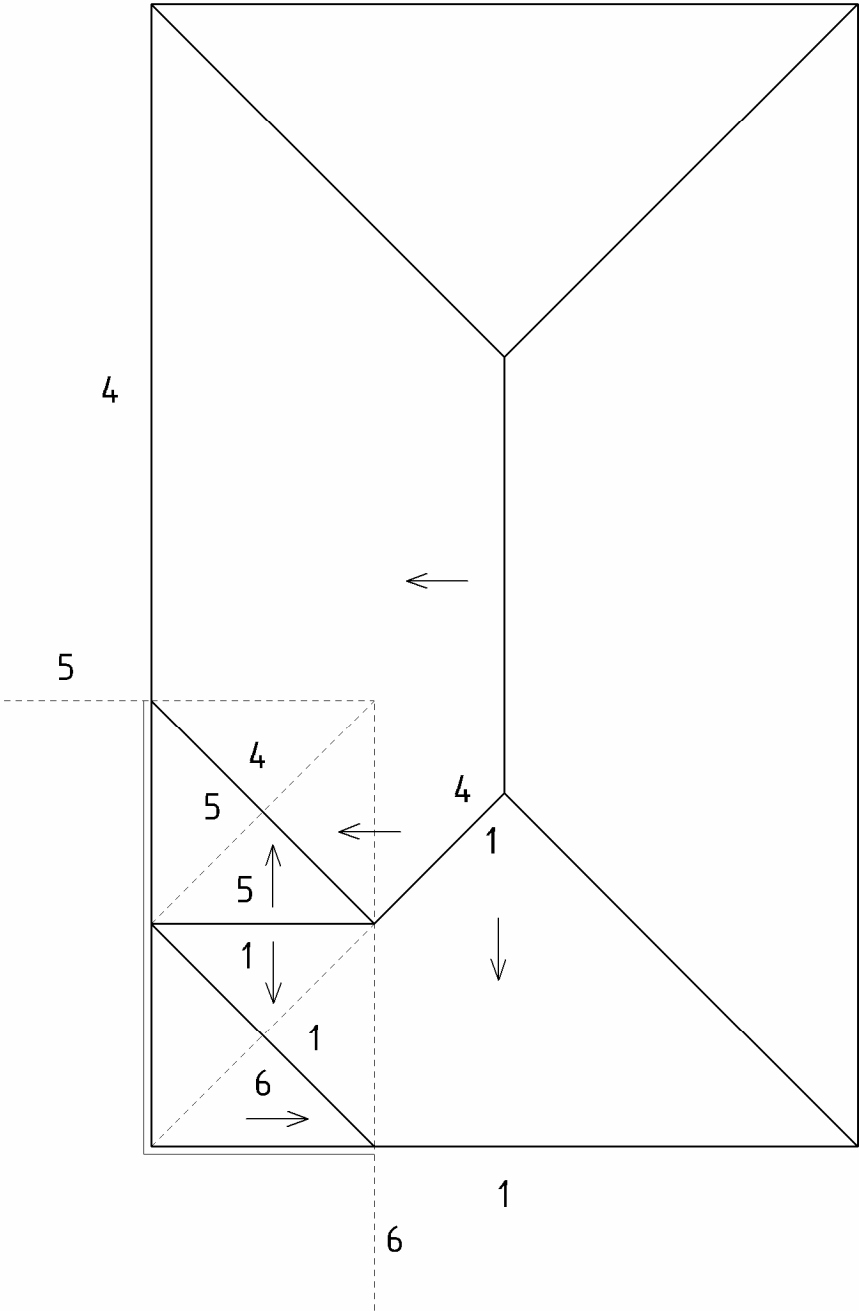
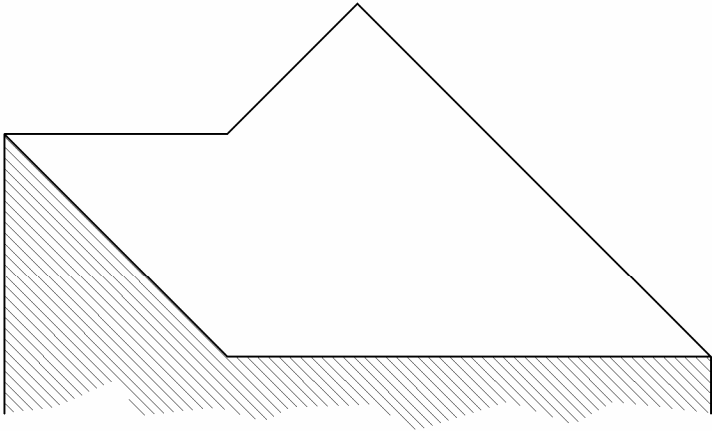

Zadání č. 4 ( a, b > 2a )

